

PPAK5X6 Pin Configuration

BVDSS	RDSON	ID
65V	3.5mΩ	120A

Features

- 65V, 120A, RDS(ON) = 3.5mΩ@VGS = 10V
- Improved dv/dt capability
- Fast switching
- Green Device Available

Applications

- Networking
- Load Switc
- LED applications

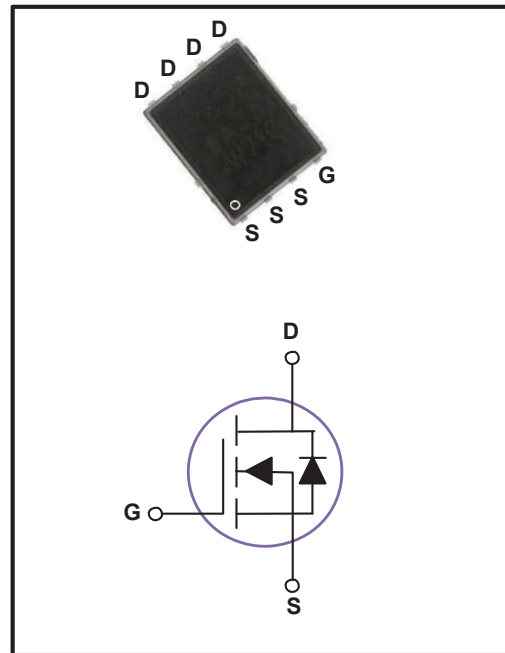

MAXIMUM RATINGS AND CHARACTERISTICS

@ 25°C Ambient Temperature (unless otherwise noted)

Parameter	Symbol	Rating	Units
Drain-Source Voltage	V _{DS}	65	V
Gate-Source Voltage	V _{GS}	±20	V
Drain Current – Continuous (T _C =25°C)	I _D	120	A
Drain Current – Continuous (T _C =100°C)		77	A
Drain Current – Pulsed ¹	I _{DM}	480	A
Single Pulse Avalanche Energy ²	EAS	218	mJ
Single Pulse Avalanche Current ²	IAS	66	A
Power Dissipation (T _C =25°C)	P _D	125	W
Power Dissipation – Derate above 25°C		1	W/°C
Storage Temperature Range	T _{STG}	-55 to 150	°C
Operating Junction Temperature Range	T _J	-55 to 150	°C

Thermal Characteristics

Parameter	Symbol	Typ.	Max.	Unit
Thermal Resistance Junction to ambient	R _{θJA}	---	62	°C/W
Thermal Resistance Junction to Case	R _{θJC}	---	1	°C/W

MOSFETELECTRICAL CHARACTERISTICS $T_A=25^{\circ}\text{C}$ unless otherwise specified

Off Characteristics

Parameter	Symbol	Conditions	Min.	Typ.	Max.	Unit
Drain-Source Breakdown Voltage	BV_{DSS}	$V_{GS}=0V, I_D=250\mu A$	65	---	---	V
Drain-Source Leakage Current	I_{DSS}	$V_{DS}=60V, V_{GS}=0V, T_J=25^{\circ}\text{C}$	---	---	1	μA
		$V_{DS}=48V, V_{GS}=0V, T_J=85^{\circ}\text{C}$	---	---	10	μA
Gate-Source Leakage Current	I_{GSS}	$V_{GS}=\pm 20V, V_{DS}=0V$	---	---	± 100	nA

On Characteristics

Static Drain-Source On-Resistance	$R_{DS(ON)}$	$V_{GS}=10V, I_D=30A$	---	2.9	3.5	$m\Omega$
		$V_{GS}=4.5V, I_D=20A$	---	4.1	5.3	$m\Omega$
Gate Threshold Voltage	$V_{GS(th)}$	$V_{GS}=V_{DS}, I_D=250\mu A$	1.2	1.6	2.5	V
Forward Transconductance	g_{fs}	$V_{DS}=10V, I_D=3A$	---	16	---	S

Dynamic and switching Characteristics

Total Gate Charge ^{3,4}	Q_g	$V_{DS}=30V, V_{GS}=10V, I_D=60A$	---	52	78	nC
Gate-Source Charge ^{3,4}	Q_{gs}		---	7	11	
Gate-Drain Charge ^{3,4}	Q_{gd}		---	18	27	
Turn-On Delay Time ^{3,4}	$T_{d(on)}$	$V_{DD}=30V, V_{GS}=10V, R_G=6\Omega, I_D=60A$	---	14	21	ns
Rise Time ^{3,4}	T_r		---	18	27	
Turn-Off Delay Time ^{3,4}	$T_{d(off)}$		---	39	59	
Fall Time ^{3,4}	T_f		---	14	21	
Input Capacitance	C_{iss}	$V_{DS}=30V, V_{GS}=0V, F=1\text{MHz}$	---	2400	3600	pF
Output Capacitance	C_{oss}		---	840	1260	
Reverse Transfer Capacitance	C_{rss}		---	37	56	
Gate resistance	R_g		$V_{GS}=0V, V_{DS}=0V, F=1\text{MHz}$	---	1.4	

Drain-Source Diode Characteristics and Maximum Ratings

Parameter	Symbol	Conditions	Min.	Typ.	Max.	Unit
Continuous Source Current	I_S	$V_G=V_D=0V, \text{Force Current}$	---	---	120	A
Pulsed Source Current	I_{SM}		---	---	240	A
Diode Forward Voltage	V_{SD}	$V_{GS}=0V, I_S=1A, T_J=25^{\circ}\text{C}$	---	---	1	V
Reverse Recovery Time ³	t_{rr}	$V_R=50V, I_S=10A$	---	65	---	ns
Reverse Recovery Charge ³	Q_{rr}	$di/dt=100A/\mu s, T_J=25^{\circ}\text{C}$	---	100	---	nC

Note :

1. Repetitive Rating : Pulsed width limited by maximum junction temperature.
2. $V_{DD}=25V, V_{GS}=10V, L=0.1mH, I_{AS}=66A, R_G=25\Omega, \text{Starting}$
3. The data tested by pulsed , pulse width $\leq 300\mu s$, duty cycle $\leq 2\%$.
4. Essentially independent of operating temperature.

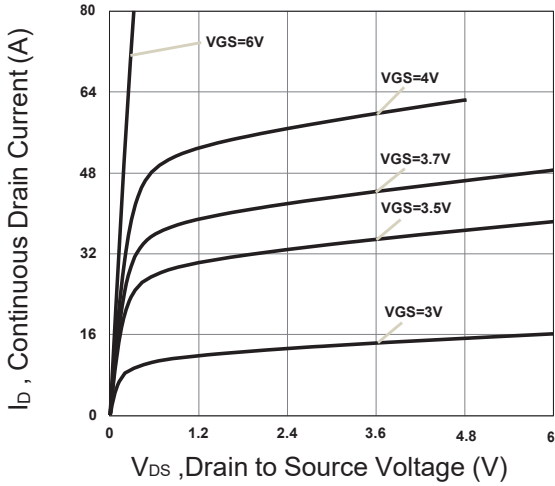

Fig.1 Typical Output Characteristics

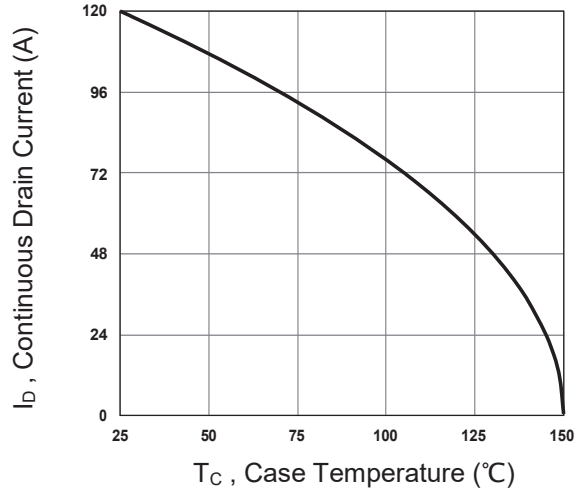

Fig.2 Continuous Drain Current vs. T_c

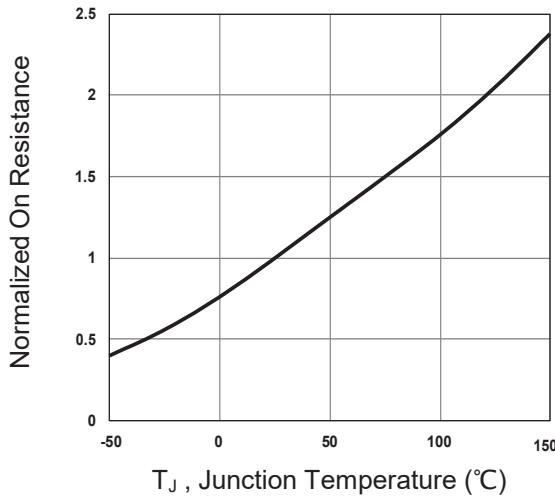

Fig.3 Normalized RDSON vs. T_j

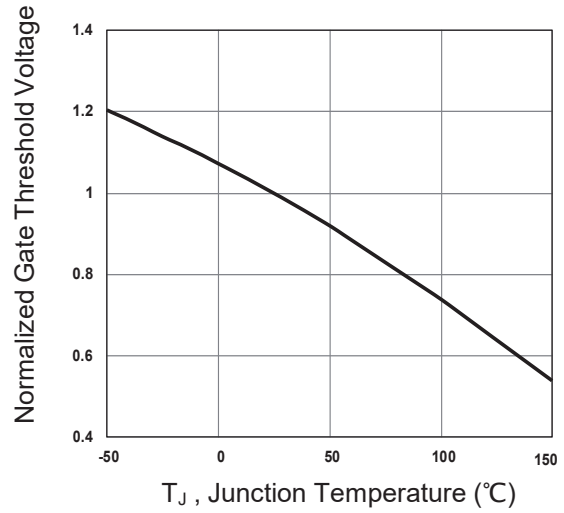

Fig.4 Normalized V_{th} vs. T_j

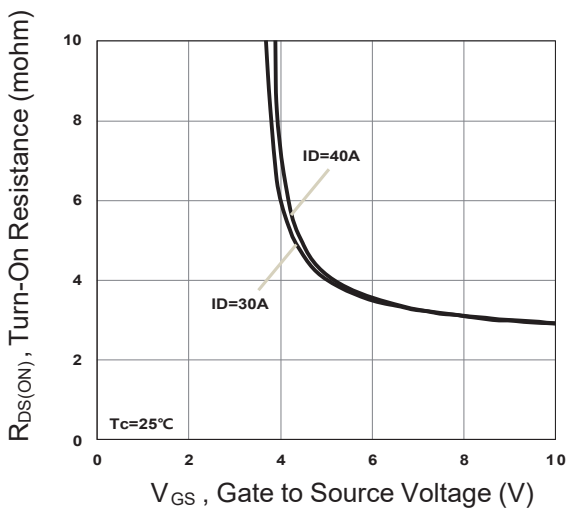

Fig.5 Turn-On Resistance vs. V_{GS}

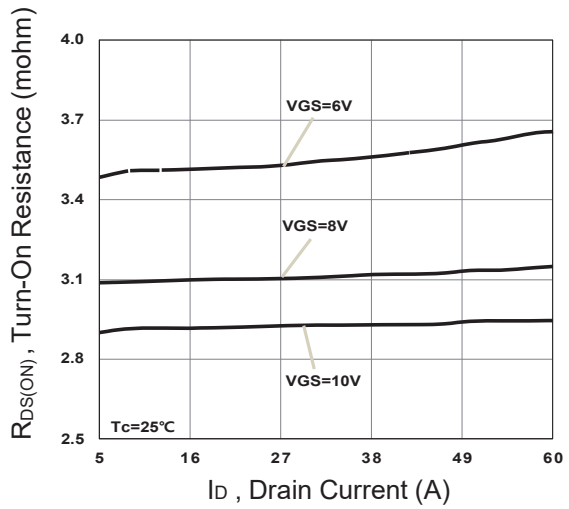

Fig.6 Turn-On Resistance vs. I_D

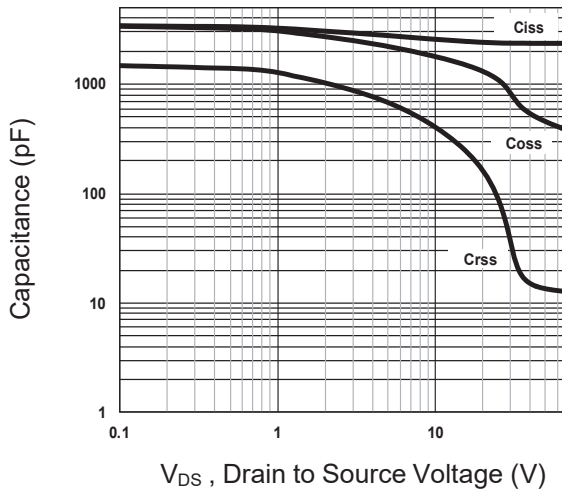

Fig.7 Capacitance Characteristics

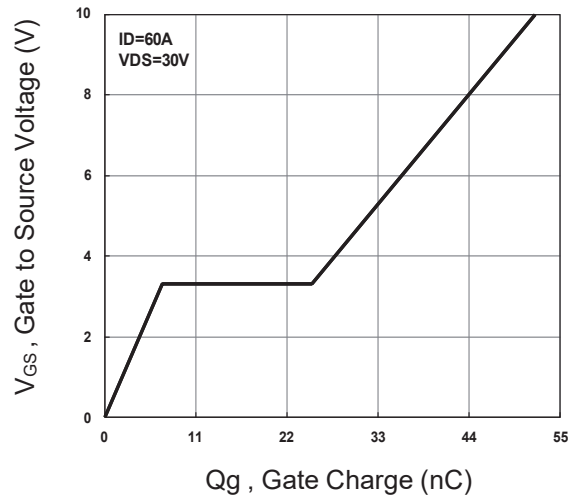

Fig.8 Gate Charge Characteristics

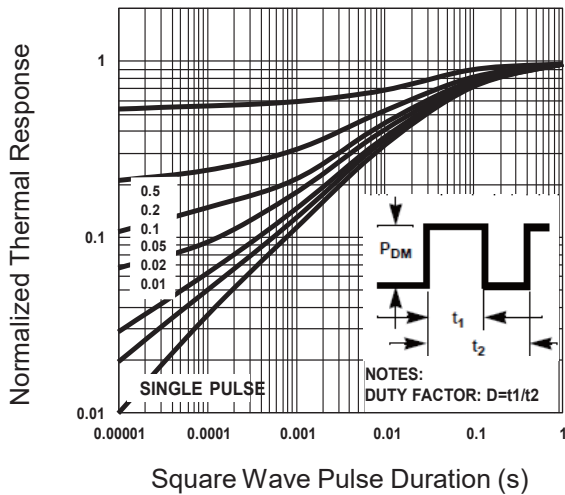

Fig.9 Normalized Transient Impedance

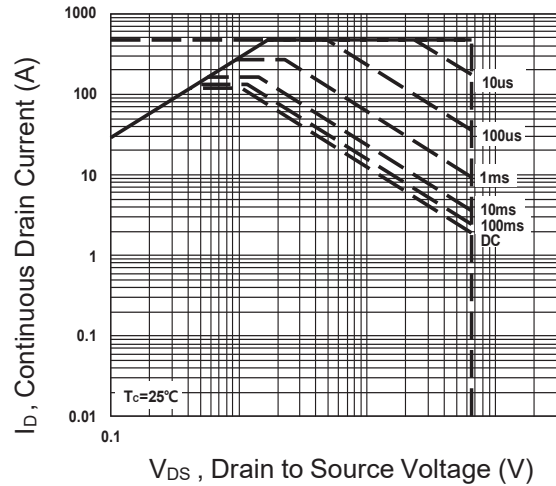

Fig.10 Maximum Safe Operation Area

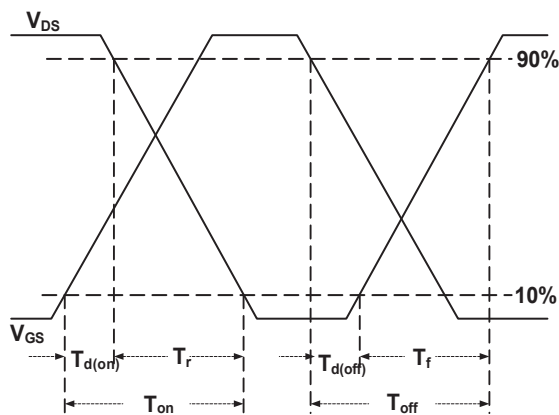

Fig.11 Switching Time Waveform

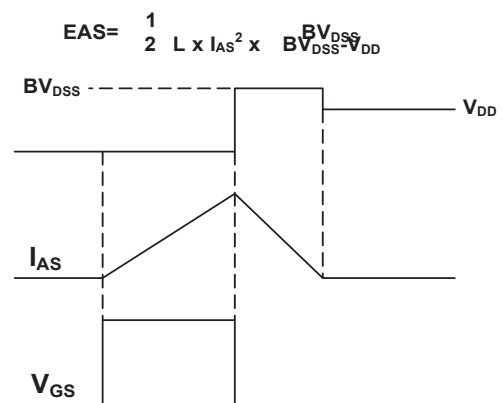
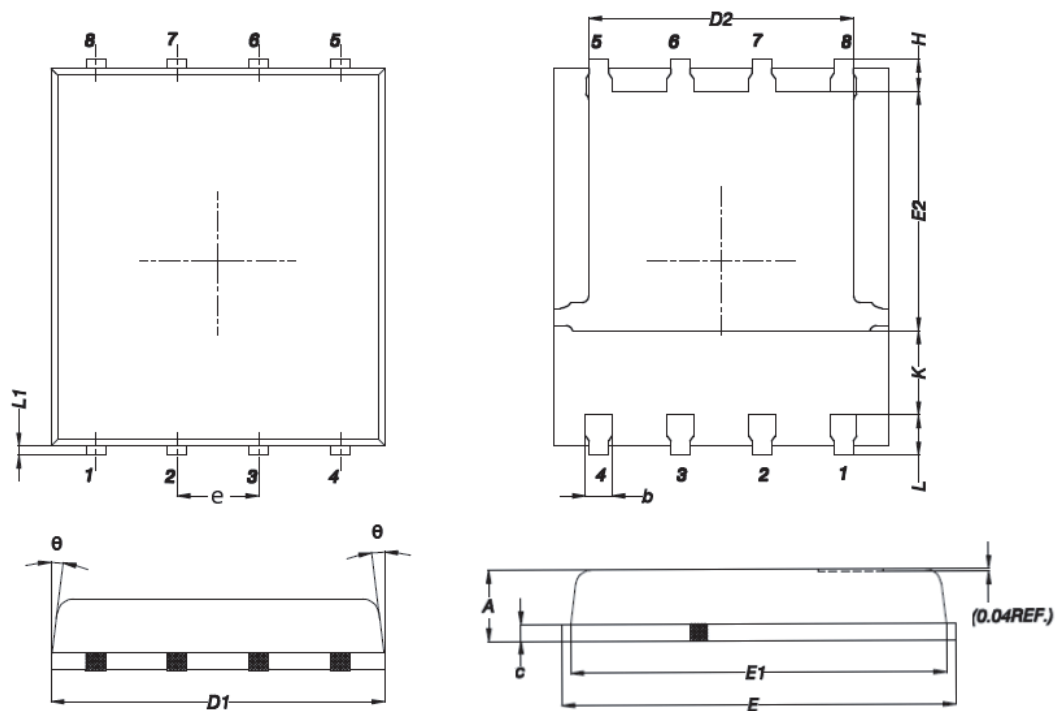

Fig.12 EAS Waveform

PPAK5x6 PACKAGE INFORMATION



Symbol	Dimensions In Millimeters				Dimensions In Inches			
	MAX			MIN	MAX			MIN
A	1.200			0.850	0.047			0.031
b	0.510			0.330	0.020			0.013
C	0.300			0.200	0.012			0.008
D1	5.400			4.800	0.212			0.189
D2	4.310			3.610	0.170			0.142
E	6.300			5.850	0.248			0.230
E1	5.960			5.450	0.235			0.215
E2	3.920			3.300	0.154			0.130
e		1.27BSC				0.05BSC		
H	0.650			0.380	0.026			0.015
K	---			1.100	---			0.043
L	0.710			0.380	0.028			0.015
L1	0.250			0.050	0.009			0.002
θ	12°			0°	12°			0°